

■ SUPPORTI DI FISSAGGIO PER VETRO

HOLED GLASS SUPPORT MOUNTS

СТАЛЬНЫЕ КРЕПЛЕНИЯ ДЛЯ СТЕКЛА

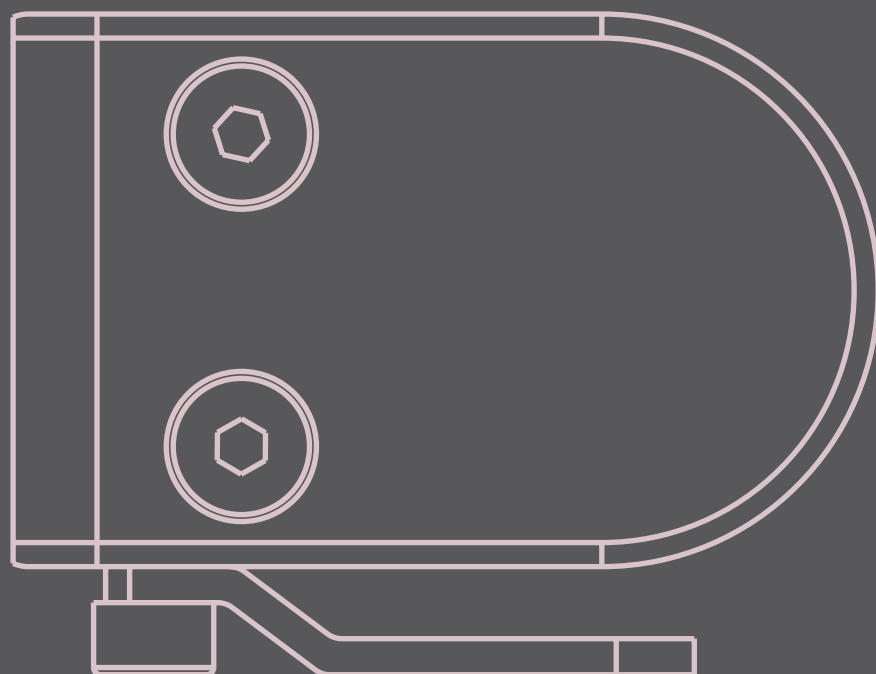

FER METAL

www.fermetal.it









madeinitaly

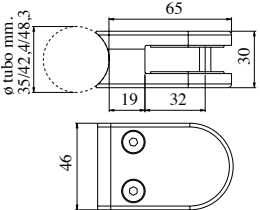

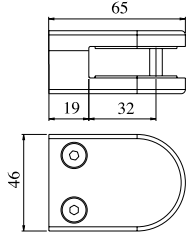
SUPPORTI DI FISSAGGIO PER VETRO IN ACCIAIO INOX AISI 316

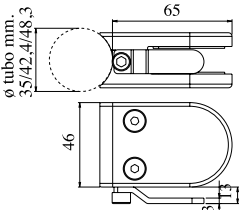
HOLED GLASS SUPPORT MOUNTS IN AISI 316 STAINLESS STEEL

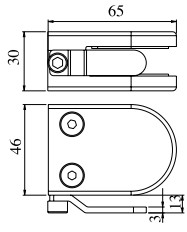
СТАЛЬНЫЕ КРЕПЛЕНИЯ ДЛЯ СТЕКЛА INOX AISI 316

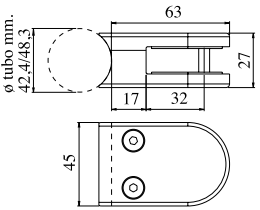
	Codice Code Артикул	Descrizione Description Описание	Dotazione Includes Оснащение	
	10635100/ *	SUPPORTO PER VETRO 46x65x30 mm BASE SGOLATA	vite M8x20 TCEI M8x20 TCEI screw шурупы M8x29TCEI	
	10642100/ *	GLASS CLAMP 46x65x30 mm GROOVED		
	10648100/ *	Крепление для стекла 46x65x30 mm рифленая поверхность		
* Completare il codice con lo spessore del vetro: 8 - 10 - 11 - 13 * Complete the code with the glass tickness: 8 - 10 - 11 - 13 * Дополнить код толщиной стекла: 8 - 10 - 11 - 13				
	10600100/ *	SUPPORTO PER VETRO 46x65x30 mm BASE PIANA	vite M8x20 TCEI M8x20 TCEI screw шурупы M8x29 TCEI	
		GLASS CLAMP 46x65x30 mm FLAT END		
		Крепление для стекла 46x65x30 mm гладкая поверхность		
* Completare il codice con lo spessore del vetro: 8 - 10 - 11 - 13 * Complete the code with the glass tickness: 8 - 10 - 11 - 13 * Дополнить код толщиной стекла: 8 - 10 - 11 - 13				
	10735100/ *	SUPPORTO PER VETRO c/mensola 46x65x30 mm BASE SGOLATA	vite M8x20 TCEI M8x20 TCEI screw шурупы M8x29 TCEI	
	10742100/ *	GLASS CLAMPw/ BRACKET 46x65x30 mm GROOVED		
	10748100/ *	Крепление для стекла. Полка 46x65x30 mm. Рифленая поверхность		
* Completare il codice con lo spessore del vetro: 8 - 10 - 11 - 13 * Complete the code with the glass tickness: 8 - 10 - 11 - 13 * Дополнить код толщиной стекла: 8 - 10 - 11 - 13				
	10700100/ *	SUPPORTO PER VETRO c/mensola 46x65x30 mm BASE PIANA	vite M8x20 TCEI M8x20 TCEI screw шурупы M8x29 TCEI	
		GLASS CLAMPw/ BRACKET 46x65x30 mm FLAT END		
		Крепление для стекла. Полка 46x65x30 mm. Гладкая поверхность		
* Completare il codice con lo spessore del vetro: 8 - 10 - 11 - 13 * Complete the code with the glass tickness: 8 - 10 - 11 - 13 * Дополнить код толщиной стекла: 8 - 10 - 11 - 13				
	10642101/ *	SUPPORTO PER VETRO 45x63x27 mm BASE SGOLATA	vite M8x20 TCEI M8x20 TCEI screw Рифленая поверхность	
		GLASS CLAMP 45x63x27 mm GROOVED		
	10648101/ *	Крепление для стекла 45x63x27 mm.		
* Completare il codice con lo spessore del vetro: 8 - 10 - 12 * Complete the code with the glass tickness: 8 - 10 - 12 * Дополнить код толщиной стекла: 8 - 10 - 12				

Codice Code Артикул	Descrizione Description Описание	Dotazione Includes Оснащение
---------------------------	--	------------------------------------



10600101/ *

SUPPORTO PER VETRO
45x63x27 mm BASE PIANA
GLASS CLAMP 45x63x27 mm
FLAT END
 Крепление для стекла
 45x63x27 mm гладкая
 поверхность

vite M8x20 TCEI
M8x20 TCEI screw
 Шуруп M8x20 TCEI

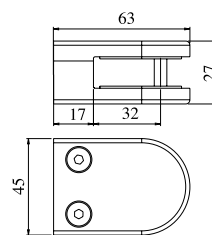

* Completare il codice con lo spessore del vetro: 8 - 10 - 12
 * Complete the code with the glass tickness: 8 - 10 - 12
 * Дополнить код толщиной стекла: 8 - 10 - 12



10742101/ *

SUPPORTO PER VETRO
c/mensola 45x63x27 mm
BASE SGOLATA
GLASS CLAMPw/ BRACKET
45x63x27 mm GROOVED
 Крепление для стекла.
 Кронштейн. 45x63x27 mm.
 Рифленая поверхность

vite M8x20 TCEI
M8x20 TCEI screw
 шуруп M8x20 TCEI

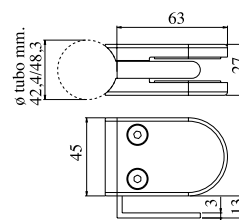

10748101/ *

* Completare il codice con lo spessore del vetro: 8 - 10 - 12
 * Complete the code with the glass tickness: 8 - 10 - 12
 * Дополнить код толщиной стекла: 8 - 10 - 12



10700101/ *

SUPPORTO PER VETRO
c/mensola 45x63x27 mm
BASE PIANA
GLASS CLAMPw/ BRACKET
45x63x27 mm FLAT END
 Крепление для стекла.
 Кронштейн. 45x63x20 mm.
 Гладкая поверхность

vite M8x20 TCEI
M8x20 TCEI screw
 Шуруп M8x20 TCEI

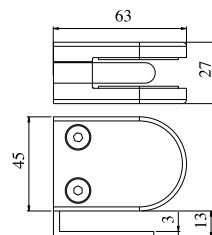

* Completare il codice con lo spessore del vetro: 8 - 10 - 12
 * Complete the code with the glass tickness: 8 - 10 - 12
 * Дополнить код толщиной стекла: 8 - 10 - 12



10635102/ *

SUPPORTO PER VETRO
40X50X27 mm BASE SGOLATA
GLASS CLAMP 40x50x27 mm
GROOVED
 Крепление для стекла
 40x50x27 mm.
 Рифленая поверхность.

vite M8x20 TCEI
M8x20 TCEI screw
 Шуруп M8x20 TCEI

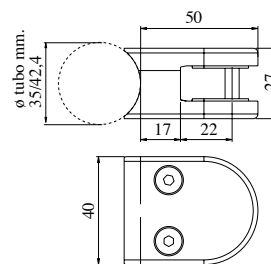

10642102/ *

* Completare il codice con lo spessore del vetro: 6 - 8 - 10
 * Complete the code with the glass tickness: 6 - 8 - 10
 * Дополнить код толщиной стекла: 6 - 8 - 10



10600102/ *

SUPPORTO PER VETRO
40X50X27 mm BASE PIANA
GLASS CLAMP 40x50x27 mm
FLAT END
 Крепление для стекла
 40x50x27 mm Гладкая
 поверхность

vite M8 TCEI
M8 TCEI screw
 Шуруп M8

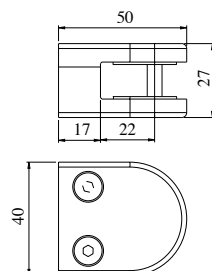

* Completare il codice con lo spessore del vetro: 6 - 8 - 10
 * Complete the code with the glass tickness: 6 - 8 - 10
 * Дополнить код толщиной стекла: 6 - 8 - 10

Codice Code Артикул	Descrizione Description Описание	Dotazione Includes Оснащение
---------------------------	--	------------------------------------



10735102/ *
SUPPORTO PER VETRO
c/mensola 40X50X27 mm
BASE SGOLATA
 GLASS CLAMPw/ BRACKET
 40x50x27 mm GROOVED

10742102/ * Крепление для стекла.
 Кронштейн. 40x50x27 mm.
 Рифленая поверхность

vite M8 TCEI
 M8 TCEI screw
 Штыри M8 TCEI

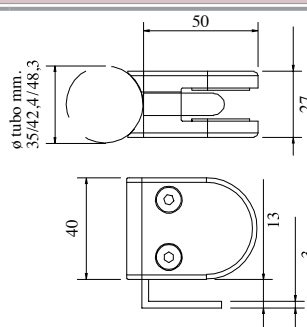

* Completare il codice con lo spessore del vetro: 6 - 8 - 10
 * Complete the code with the glass thickness: 6 - 8 - 10
 * Дополнить код толщиной стекла: 6 - 8 - 10



10700102/ *
SUPPORTO PER VETRO
c/mensola 40X50X27 mm
BASE PIANA
 GLASS CLAMPw/ BRACKET
 40x50x27 mm FLAT END

Крепление для стекла.
 Кронштейн. 40x50x27 mm.
 Гладкая поверхность

vite M8 TCEI
 M8 TCEI screw
 Штыри M8 TCEI

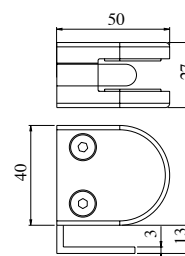

* Completare il codice con lo spessore del vetro: 6 - 8 - 10
 * Complete the code with the glass thickness: 6 - 8 - 10
 * Дополнить код толщиной стекла: 6 - 8 - 10

Codice Code Артикул	Descrizione Description Описание	Finitura di serie Mass-produced finishing Материал
---------------------------	--	--



10600103/21
SUPPORTO PER VETRO
80x78x42 mm per vetro sp. 18/21 mm
grana 320
 GLASS CLAMP 80x78x42 mm
 18/21 mm glass thickness
 Крепление для стекла.
 80x78x42 mm для стекла 18/21 mm.

Inox satinato
grana 320
 Satin finished 320 grit
 stainless steel
 нержавеющая сталь
 К 320

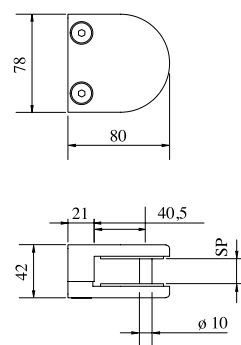

10600103/21L
SUPPORTO PER VETRO
80x78x42 mm per vetro sp. 18/21 mm
Inox lucido
 GLASS CLAMP 80x78x42 mm
 18/21 mm glass thickness
 Крепление для стекла 80x78x42 mm
 Для стекла 18/21 mm

Inox lucido
 Shiny stainless steel
 Полированная
 нержавеющая сталь

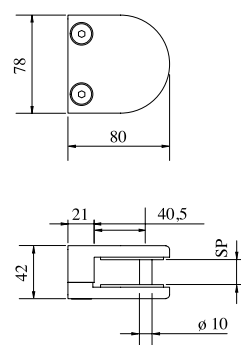



FER METAL s.n.c.
di Feriseri Francesco e C.

■ Sede legale:

Via Marconi. 141/A
25071 Agnosine (BS) - Italy

■ Uffici e stabilimento:

Via Madonna di Calchere, 32/34
25071 Agnosine (BS) - Italy
Tel. + 39 0365 896168
Fax + 39 0365 897454

info@fermetal.it

■ www.fermetal.it